

S9015 TRANSISTOR (PNP)

FEATURES

- High total power dissipation. ($P_C=0.45W$)
- High h_{FE} and good linearity
- Complementary to S9014

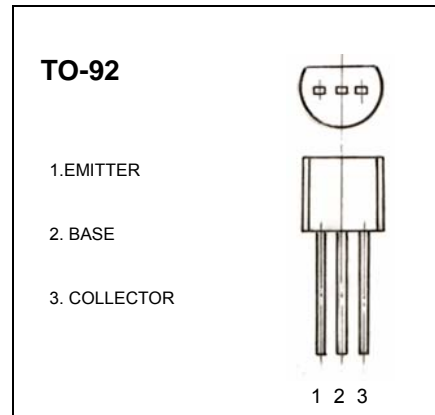

MAXIMUM RATINGS ($T_A=25^{\circ}C$ unless otherwise noted)

Symbol	Parameter	Value	Units
V_{CBO}	Collector-Base Voltage	-50	V
V_{CEO}	Collector-Emitter Voltage	-45	V
V_{EBO}	Emitter-Base Voltage	-5	V
I_C	Collector Current -Continuous	-0.1	A
P_C	Collector Power Dissipation	0.45	W
T_j	Junction Temperature	150	$^{\circ}C$
T_{stg}	Storage Temperature	-55-150	$^{\circ}C$

ELECTRICAL CHARACTERISTICS ($T_{amb}=25^{\circ}C$ unless otherwise specified)

Parameter	Symbol	Test conditions	MIN	TYP	MAX	UNIT
Collector-base breakdown voltage	$V_{(BR)CBO}$	$I_C = -100\mu A, I_E = 0$	-50			V
Collector-emitter breakdown voltage	$V_{(BR)CEO}$	$I_C = -1mA, I_B = 0$	-45			V
Emitter-base breakdown voltage	$V_{(BR)EBO}$	$I_E = -100\mu A, I_C = 0$	-5			V
Collector cut-off current	I_{CBO}	$V_{CB} = -50V, I_E = 0$			-0.05	μA
Emitter cut-off current	I_{EBO}	$V_{EB} = -5V, I_C = 0$			-0.05	μA
DC current gain	h_{FE}	$V_{CE} = -5V, I_C = -1mA$	60		1000	
Collector-emitter saturation voltage	$V_{CE(sat)}$	$I_C = -100mA, I_B = -10mA$			-0.3	V
Base-emitter saturation voltage	$V_{BE(sat)}$	$I_C = -100mA, I_B = -10mA$			-1	V
Transition frequency	f_T	$V_{CE} = -5V, I_C = -10mA$ $f = 30MHz$	100			MHz

CLASSIFICATION OF $h_{FE(1)}$

Rank	A	B	C	D
Range	60-150	250-300	300-400	400-1000

Typical Characteristics

S9015

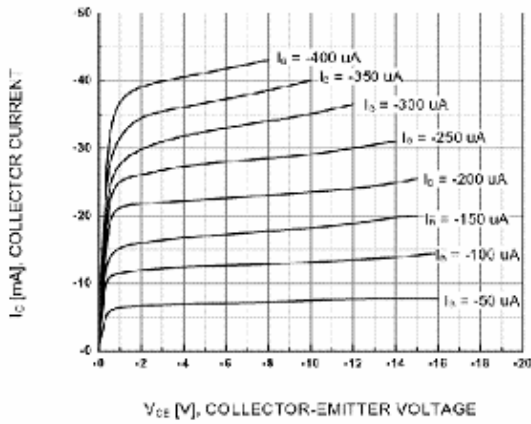

Figure 1. Static Characteristic

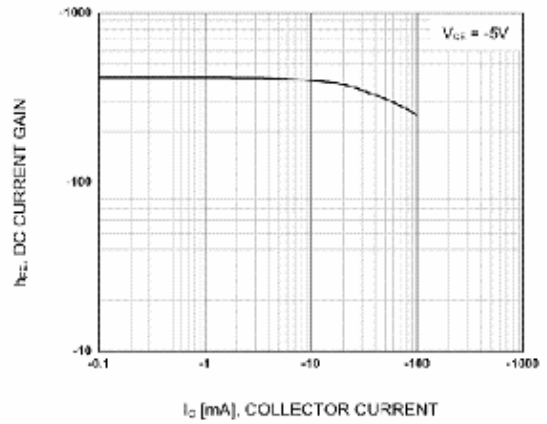
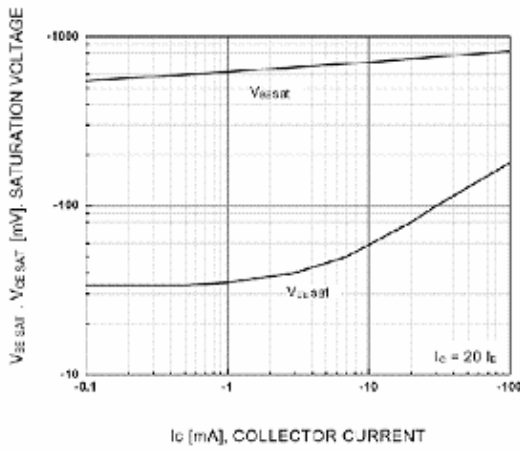

Figure 2. DC current Gain



**Figure 3. Base-Emitter Saturation Voltage
Collector-Emitter Saturation Voltage**

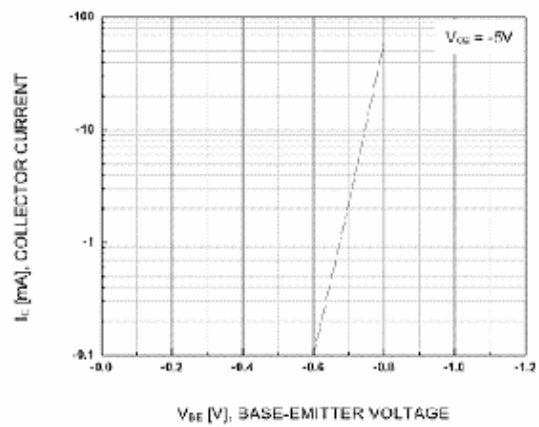

Figure 4. Base-Emitter On Voltage

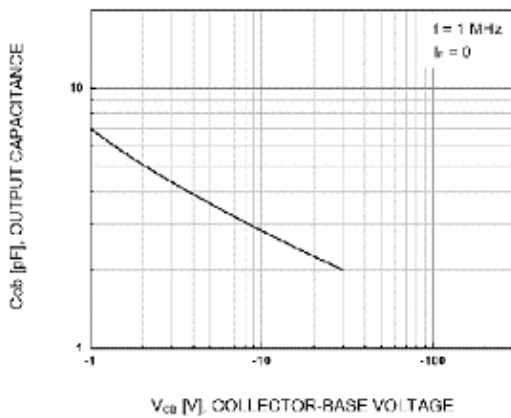

Figure 5. Collector Output Capacitance

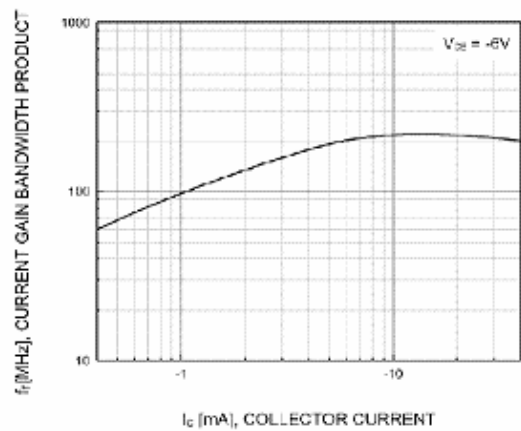

Figure 6. Current Gain Bandwidth Product